

Thermomagnetic device circuit breaker - CB TM1 5A SFB P - 2800840

Please be informed that the data shown in this PDF Document is generated from our Online Catalog. Please find the complete data in the user's documentation. Our General Terms of Use for Downloads are valid (<http://phoenixcontact.com/download>)



Thermomagnetic device circuit breaker, 1-pos., tripping characteristic SFB, 1 changeover contact, plug for base element.

Your advantages

- ✓ Individually adjustable with protective plugs
- ✓ Fuse protection for above-average conductor lengths with the aid of the SFB characteristic curve
- ✓ Protective plug with fixed nominal current value as protection against unintentional changes
- ✓ Increased safety with electrical isolation in the event of errors



Key Commercial Data

| | |
|--------------------------------------|---|
| Packing unit | 1 pc |
| GTIN |  4 046356 689915 |
| GTIN | 4046356689915 |
| Weight per Piece (excluding packing) | 40.000 g |
| Custom tariff number | 85362010 |
| Country of origin | Indonesia |

Technical data

Dimensions

| | |
|------------------------|---------|
| Height | 45 mm |
| Width | 12.3 mm |
| Depth | 52 mm |
| Complete module height | 90 mm |
| Complete module width | 12.3 mm |

Thermomagnetic device circuit breaker - CB TM1 5A SFB P - 2800840

Technical data

Dimensions

| | |
|-----------------------|---------|
| Complete module depth | 77.3 mm |
|-----------------------|---------|

Ambient conditions

| | |
|---|-------------------------------|
| Ambient temperature (operation) | -30 °C ... 60 °C |
| Ambient temperature (storage/transport) | -40 °C ... 80 °C |
| Humidity test | 240 h, 95 % RH, 40 °C |
| Shock (operation) | 30g (IEC 60068-2-27, Test Ea) |
| Vibration (operation) | 8g (IEC 60068-2-6, Test Fc) |
| Degree of protection | IP30 (Actuation area) |

General

| | |
|--|---|
| Assembly note | When mounted in rows, the nominal device current can be limited to just 80% or must be oversized accordingly. |
| Flammability rating according to UL 94 | V-0 |
| Mounting type | on base element |
| Color | gray |
| Number of positions | 1 |
| Insulating material group | II |
| Degree of pollution | 2 |
| Type | Male |

Electrical data

| | |
|---|---|
| Fuse type | SFB |
| Rated surge voltage | 2.5 kV (Increased insulation in actuation area) |
| Rated voltage | 50 V DC (IEC 60934) |
| | 50 V DC (UL 1077) |
| | 50 V DC (UL 508 - with plug-in base) |
| Rated current I_N | 5 A (IEC 60934) |
| | 5 A DC (low-induction load according to UL 1077) |
| | 5 A DC (low-induction load according to UL 508 - with plug-in base) |
| Rated insulation voltage U_i | 277 V AC (UL 1077) |
| | 250 V AC (IEC 60934) |
| Power dissipation | 1.5 W (in nominal operation per channel) |
| Device resistance | 60 mΩ |
| Insulation resistance R_{iso} | > 100 MΩ (500 V DC) |
| Type of actuation | S type |
| Tripping method | TM (thermomagnetic) |
| Tripping level | Trip-free mechanism (positive) |
| Rated short-circuit switching capacity I_{cn} | 600 A (50 V DC) |

Thermomagnetic device circuit breaker - CB TM1 5A SFB P - 2800840

Technical data

Electrical data

| | |
|---|--|
| Required backup fuse | 20 A ($I > I_{cn}$) |
| Short-circuit switching capacity | 1000 A AC (277 V AC) |
| | 1000 A DC (50 V DC) |
| Dielectric strength | 3000 V AC (Actuation area) |
| | 1500 V AC (Main to auxiliary circuit) |
| | 1500 V AC (Open main circuit) |
| | 1000 V AC (Open auxiliary circuit) |
| Voltage drop | 0.31 V (at $1 \times I_n$) |
| Switching cycles, max. | 6000 (at $1 \times I_n$) |
| Auxiliary circuit | 277 V AC / 0.5 A (Low-induction) |
| | 277 V AC / 1 A (Low-induction, maximum of 2000 cycles) |
| | 50 V DC / 1 A (Low-induction) |
| Minimum auxiliary contact operating voltage | 10 V |
| Maximum auxiliary contact operating voltage | 240 V |
| | 240 V |
| Minimum auxiliary contact operating current | 10 mA |
| Maximum auxiliary contact operating current | 1 A |

Standards and Regulations

| | |
|--------------------------|----------|
| Standards/specifications | EN 60934 |
|--------------------------|----------|

Conformance/approvals

| | |
|----------------|------------------------------|
| Designation | UL approval |
| Identification | UL Listed UL 508 |
| | UL/C-UL Recognized UL 1077 |
| Designation | CSA |
| Identification | CSA CAN/CSA-C22.2 No. 235-04 |
| Designation | Shipbuilding approval |
| Identification | DNV GL |

Environmental Product Compliance

| | |
|------------|---|
| REACH SVHC | Lead 7439-92-1 |
| China RoHS | Environmentally Friendly Use Period = 25; |
| | For details about hazardous substances go to tab "Downloads", Category "Manufacturer's declaration" |

Drawings

Thermomagnetic device circuit breaker - CB TM1 5A SFB P - 2800840

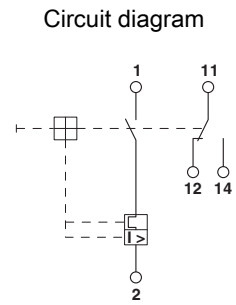
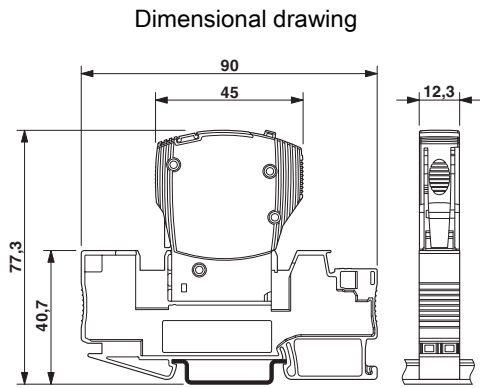

The figure shows the complete module consisting of a base element and connector

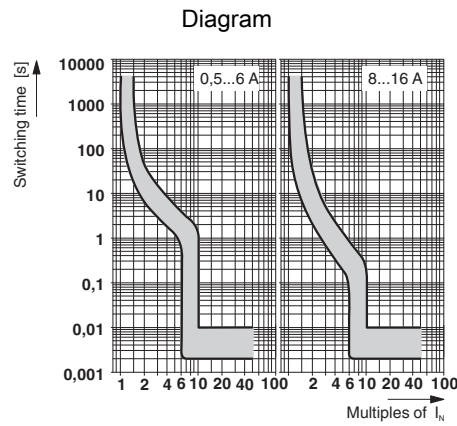

Trigger characteristic in the DC range

Thermomagnetic device circuit breaker - CB TM1 5A SFB P - 2800840

Application drawing

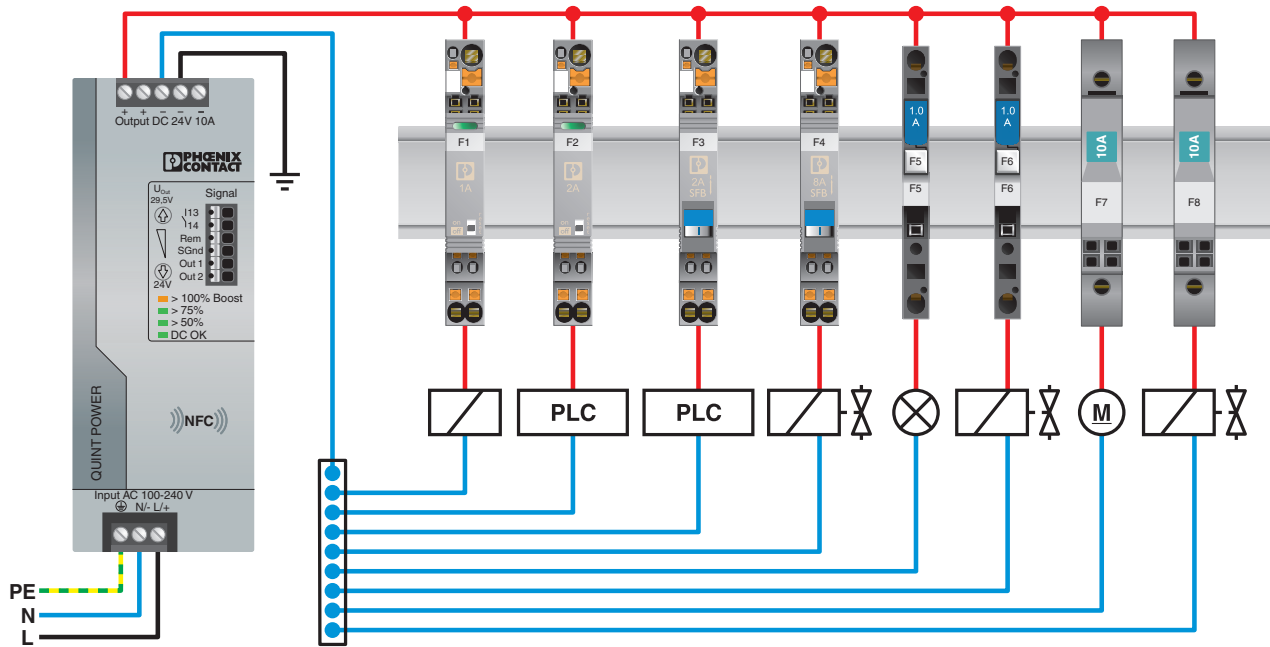

Thermomagnetic device circuit breaker - CB TM1 5A SFB P - 2800840

Application drawing



Classifications

eCl@ss

| | |
|---------------|----------|
| eCl@ss 10.0.1 | 27140401 |
| eCl@ss 11.0 | 27140401 |
| eCl@ss 4.0 | 27141100 |
| eCl@ss 4.1 | 27141100 |
| eCl@ss 5.0 | 27141100 |
| eCl@ss 5.1 | 27141100 |
| eCl@ss 6.0 | 27141100 |
| eCl@ss 7.0 | 27141116 |
| eCl@ss 9.0 | 27141116 |

ETIM

| | |
|----------|----------|
| ETIM 3.0 | EC000899 |
| ETIM 4.0 | EC000899 |

Thermomagnetic device circuit breaker - CB TM1 5A SFB P - 2800840

Classifications

ETIM

| | |
|----------|----------|
| ETIM 6.0 | EC000899 |
|----------|----------|

UNSPSC

| | |
|---------------|----------|
| UNSPSC 6.01 | 30211812 |
| UNSPSC 7.0901 | 39121411 |
| UNSPSC 11 | 39121411 |
| UNSPSC 12.01 | 39121411 |
| UNSPSC 13.2 | 39121410 |
| UNSPSC 18.0 | 39121410 |
| UNSPSC 19.0 | 39121410 |
| UNSPSC 20.0 | 39121410 |
| UNSPSC 21.0 | 39121410 |

Approvals

Approvals

Approvals

CSA / UL Listed / UL Recognized / cUL Recognized / cUL Listed / EAC / KC / DNV GL / CCC / EAC / VDE Zeichengenehmigung / cULus Recognized / cULus Listed

Ex Approvals

Approval details

| | | | |
|-----|---|---|---------|
| CSA |  | http://www.csagroup.org/services-industries/product-listing/ | 2786957 |
|-----|---|---|---------|

| | | | |
|-----------|---|---|---------------|
| UL Listed |  | http://database.ul.com/cgi-bin/XYV/template/LISEXT/1FRAME/index.htm | FILE E 172140 |
|-----------|---|---|---------------|

| | | | |
|---------------|---|---|---------------|
| UL Recognized |  | http://database.ul.com/cgi-bin/XYV/template/LISEXT/1FRAME/index.htm | FILE E 140459 |
|---------------|---|---|---------------|

Thermomagnetic device circuit breaker - CB TM1 5A SFB P - 2800840

Approvals

| | | | |
|------------------------|--|---|-------------------------|
| cUL Recognized | | http://database.ul.com/cgi-bin/XYV/template/LISEXT/1FRAME/index.htm | FILE E 140459 |
| cUL Listed | | http://database.ul.com/cgi-bin/XYV/template/LISEXT/1FRAME/index.htm | FILE E 172140 |
| EAC | | | EAC-Zulassung |
| KC | | http://eng.kcc.go.kr/user/ehpMain.do | SW05012-15002 |
| DNV GL | | https://approvalfinder.dnvgl.com/ | TAE00003C7 |
| CCC | | | 2019010307158887 |
| EAC | | | RU C- DE.*09.B.00169 |
| VDE Zeichengenehmigung | | http://www2.vde.com/de/Institut/Online-Service/VDE-gepruefteProdukte/Seiten/Online-Suche.aspx | 40034683 |
| cULus Recognized | | | |

Thermomagnetic device circuit breaker - CB TM1 5A SFB P - 2800840

Approvals

cULus Listed



Accessories

Accessories

Bridge

Bridge - CB PT BRIDGE - 2801014



Bridge plug for bridging contacts 1 to 2 for CB base elements

Bridge - CB RC BRIDGE - 2801616



Bridge plug for bridging contacts 11 to 14 for CB base elements

Cutting tools

Front cutter - CUTFOX-FBS - 1212124



Cutting tool, for separating individual jumper bars from FBS ... plug-in bridges and EB ... insertion bridges

Jumper

Thermomagnetic device circuit breaker - CB TM1 5A SFB P - 2800840

Accessories

Plug-in bridge - FBS 2-6 - 3030336



Plug-in bridge, pitch: 6.2 mm, color: red

Plug-in bridge - FBS 3-6 - 3030242



Plug-in bridge, pitch: 6.2 mm, color: red

Plug-in bridge - FBS 4-6 - 3030255



Plug-in bridge, pitch: 6.2 mm, color: red

Plug-in bridge - FBS 5-6 - 3030349



Plug-in bridge, pitch: 6.2 mm, color: red

Plug-in bridge - FBS 10-6 - 3030271



Plug-in bridge, pitch: 6.2 mm, color: red

Thermomagnetic device circuit breaker - CB TM1 5A SFB P - 2800840

Accessories

Plug-in bridge - FBS 20-6 - 3030365



Plug-in bridge, pitch: 6.2 mm, color: red

Plug-in bridge - FBS 50-6 - 3032224



Plug-in bridge, pitch: 6.2 mm, color: red

Labeled terminal marker

Zack Marker strip, flat - ZBF 12 CUS - 0825018



Zack Marker strip, flat, can be ordered: Strip, white, labeled according to customer specifications, mounting type: snap into flat marker groove, for terminal block width: 12 mm, lettering field size: 5.15 x 12.15 mm, Number of individual labels: 5

Terminal marking

Zack Marker strip, flat - ZBF 12:UNBEDRUCKT - 0809735



Zack Marker strip, flat, Strip, white, unlabeled, can be labeled with: PLOTMARK, CMS-P1-PLOTTER, mounting type: snap into flat marker groove, for terminal block width: 12 mm, lettering field size: 5.15 x 12.15 mm, Number of individual labels: 5

Necessary add-on products

Thermomagnetic device circuit breaker - CB TM1 5A SFB P - 2800840

Accessories

Base element - CB 1/6-2/4 PT-BE - 2800929



Base element with push-in connection technology for CB ... device circuit breakers

Base element - CB 1/10-1/10 UT-BE - 2801305



Base element with screw connection technology for CB... device circuit breakers
